

Dell™ PowerEdge™ 6850 Systems User's Guide

[System Overview](#)

[Using the Dell OpenManage Server Assistant](#)

[Using the System Setup Program](#)

[Technical Specifications](#)

[Using Console Redirection](#)

[Glossary](#)

Model EMM

Notes, Notices, and Cautions



NOTE: A NOTE indicates important information that helps you make better use of your computer.



NOTICE: A NOTICE indicates either potential damage to hardware or loss of data and tells you how to avoid the problem.



CAUTION: A CAUTION indicates a potential for property damage, personal injury, or death.

Abbreviations and Acronyms

For a complete list of abbreviations and acronyms, see the Glossary.

Information in this document is subject to change without notice.

© 2004 Dell Inc. All rights reserved.

Reproduction in any manner whatsoever without the written permission of Dell Inc. is strictly forbidden.

Trademarks used in this text: *Dell*, the *DELL* logo, *PowerEdge*, and *Dell OpenManage* are trademarks of Dell Inc.; *Intel* is a registered trademark and *Xeon* is a trademark of Intel Corporation; *Microsoft*, *Windows*, and *MS-DOS* are registered trademarks of Microsoft Corporation; *Red Hat* is a registered trademark of Red Hat, Inc.; *UNIX* is a registered trademark of The Open Group in the United States and other countries.

Other trademarks and trade names may be used in this document to refer to either the entities claiming the marks and names or their products. Dell Inc. disclaims any proprietary interest in trademarks and trade names other than its own.

December 2004 P/N F2332 Rev. A00

Technical Specifications

Dell™ PowerEdge™ 6850 Systems User's Guide

Processor	
Processor type	up to four Intel® Xeon™ processors with a minimum clock speed of at least 3.16 GHz
Front-side bus speed	667 MHz
Internal cache	at least 1 MB

Expansion Bus	
Bus type	PCI-X and PCIe
Expansion slots	
PCI-X	one hot-pluggable 3.3-V, 64-bit, 133-MHz (slot 2); two 3.3-V, 64-bit, 100-MHz (slots 6 and 7)
PCIe	three hot-pluggable x4 lane (slots 3 through 5) one hot-pluggable x8 lane (slot 1)

Memory	
Architecture	144-bit ECC registered PC2-3200 DDR2 SDRAM DIMMs, with two-way interleaving, rated for 400-MHz operation
Memory risers	up to four interleaved memory risers, each with four 240-pin memory module DIMM sockets
Memory module capacities	256 MB, 512 MB, 1 GB, 2 GB, or 4 GB (when available)
Minimum RAM	512 MB (two 256-MB modules)
Maximum RAM	64 GB

Drives	
SCSI hard drives	up to five 1-inch, internal, hot-plug, U320 SCSI
Diskette drive	one optional 3.5-inch, 1.44-MB external optional USB 3.5-inch, 1.44-MB
Optical drive	one optional IDE CD, DVD, or combination CD-RW/DVD NOTE: DVD devices are data only. external optional USB CD
Flash drive	external optional USB

Connectors	
Externally accessible	
Back	
NIC	two RJ-45 (for integrated 1-GB NICs)
Serial	9-pin, DTE, 16550-compatible
USB	two 4-pin, USB 2.0-compliant
Video	15-pin VGA
Front	
Video	15-pin VGA
USB	two 4-pin, USB 2.0-compliant
Internally accessible	
SCSI channels	two 68-pin U320 SCSI

--	--

Video	
Video type	ATI Radeon 7000 video controller; VGA connectors
Video memory	16 MB

Power	
AC power supply (per power supply)	
Wattage	1470 W
Voltage	170–264 VAC, autoranging, 47–63 Hz, 11.43 A
Heat dissipation	1614.3 BTU/hr maximum
Maximum inrush current	Under typical line conditions and over the entire system ambient operating range, the inrush current may reach 55 A per power supply for 10 ms or less and 25 A per power supply for up to 150 ms.
Batteries	
System battery	CR 2032 3.0-V lithium ion coin cell
ROMB battery (optional)	4.1-V lithium ion

Physical	
Height	17.27 cm (6.8 in)
Width	44.70 cm (17.6 in)
Depth	70.10 cm (27.6 in)
Weight (maximum configuration)	41.73 kg (92 lb)

Environmental	
NOTE: For additional information about environmental measurements for specific system configurations, see www.dell.com/environmental_datasheets .	
Temperature	
Operating	10° to 35°C (50° to 95°F)
Storage	–40° to 65°C (–40° to 149°F)
Relative humidity	
Operating	8% to 85% (noncondensing) with a maximum humidity gradation of 10% per hour
Storage	5% to 95% (noncondensing)
Maximum vibration	
Operating	0.25 G at 3–200 Hz for 15 min
Storage	0.5 G at 3–200 Hz for 15 min
Maximum shock	
Operating	One shock pulse in the positive z axis (one pulse on each side of the system) of 41 G for up to 2 ms
Storage	Six consecutively executed shock pulses in the positive and negative x, y, and z axes (one pulse on each side of the system) of 71 G for up to 2 ms
Altitude	
Operating	–16 to 3048 m (–50 to 10,000 ft)
Storage	–16 to 10,600 m (–50 to 35,000 ft)

[Back to Contents Page](#)

[Back to Contents Page](#)

Using Console Redirection

Dell™ PowerEdge™ 6850 Systems User's Guide

- [Hardware Requirements](#)
- [Software Requirements](#)
- [Configuring the Host System](#)
- [Configuring the Client System](#)
- [Managing the Host System Remotely](#)
- [Configuring Special Key Functions](#)

Console redirection allows you to manage a host (local) system from a client (remote) system by redirecting keyboard input and text output through a serial port. You cannot redirect graphic output. You can use console redirection for tasks such as configuring BIOS or RAID settings.

You can also connect the client system to a port concentrator that can access numerous host systems using a shared modem. After logging into the port concentrator, you can select a host system to manage using console redirection.

This section describes the most basic connection possible: connecting systems using a null-modem serial cable, which directly connects the serial ports on two systems.

Hardware Requirements

- 1 An available serial (COM) port on the host system

You can use either the COM1 or COM2 port.

- 1 An available serial (COM) port on a client system

This port must not conflict with any other ports on the client system.

- 1 A null-modem serial cable to connect the host system to the client system
-

Software Requirements

- 1 VT 100/220 or ANSI terminal emulation with a window size of 80 x 25 characters
- 1 9600, 19.2 K, 57.6 K, or 115.2 K bps using serial (COM) ports

 **NOTE:** When console redirection is running at a slower baud rate, System Setup responds slowly to input from the keyboard. Data is not lost. This is a known behavior.

- 1 Ability to create keyboard command macros (recommended)

All versions of the Microsoft® Windows® operating system include Hilgraeve's HyperTerminal terminal emulation software. However, the included version does not provide many functions required during console redirection. Either upgrade to HyperTerminal Private Edition 6.1 or later, or select new terminal emulation software.

Configuring the Host System

Configure console redirection on the host (local) system through the System Setup program (see "[Console Redirection Screen](#)" in "Using the System Setup Program"). The **Console Redirection** screen allows you to enable or disable the console redirection feature, select the remote terminal type, and enable or disable console redirection after booting.

Configuring the Client System

After configuring the host system, configure the ports and terminal settings for the client (remote) system.

 **NOTE:** The examples in this section assume that you have upgraded to Hilgraeve's HyperTerminal Private Edition 6.1 or later. If you are using other terminal emulation software, see the documentation for that software.

Configuring the Serial Port

1. Click the **Start** button, point to **Programs**→**Accessories**→**Communications**, and then click **HyperTerminal**.
2. Enter a name for the new connection, select an icon, and then click **OK**.

3. From the **Connect to** dropdown menu, select an available COM port, and then click **OK**.

After you select an available COM port, the COM port properties window appears.

4. Configure the port with the following settings:

- 1 Set **Bits per second**.

Console redirection supports only 9600, 19.2 K, 57.6 K, or 115.2 K bps.

- 1 Set **Data bits** to **8**.

- 1 Set **Parity** to **None**.

- 1 Set **Stop bits** to **1**.

- 1 Set **Flow control** to **Hardware**.

- 1 Click **OK**.

Configuring the Terminal Settings

1. In HyperTerminal, click **File**, click **Properties**, and then click the **Settings** tab.
2. Ensure that the **Function, arrow, and Ctrl keys act as** field is set to **Terminal Keys**.
3. Ensure that the **Backspace key sends** field is set to **Ctrl+H**.
4. Change the **Emulation** setting from **Auto detect** to **ANSI** or **VT 100/220**.

Ensure that this setting is the same as the setting you selected for the **Console Redirection** option on the host system.

5. Click **Terminal Setup**.

A setting for the number of rows and columns appears.

6. Change the number of rows from **24** to **25** and leave the number of columns at **80**.

If you do not have these settings, you must upgrade your terminal emulation software.

7. Click **OK** twice.

Managing the Host System Remotely

After you configure the host and client systems (see "[Configuring the Host System](#)" and "[Configuring the Client System](#)"), you can use console redirection to restart a host system or to change a host system's configuration settings.

1. Reboot the host system using the client system.

See "[Configuring Special Key Functions](#)" for instructions.

2. When the host system begins to boot, use console redirection to:

- 1 Enter the System Setup program
- 1 Enter the SCSI setup menus
- 1 Update firmware and BIOS (flash the system)
- 1 Run utilities on the utility partition

 **NOTE:** To run utilities on the host system's utility partition, you must have created the utility partition using Dell OpenManage™ Server Assistant version 6.3.1 or later.

Configuring Special Key Functions

Console redirection uses ANSI or VT 100/220 terminal emulation, which is limited to basic ASCII characters. Function keys, arrow keys, and control keys are not available in the ASCII character set, and most utilities require function keys and control keys for ordinary operations. However, you can emulate a function key or control key using a special key sequence, called an escape sequence.

An escape sequence starts with an escape character. You can enter this character in different ways, depending on the requirements of your terminal

emulation software. For example, 0x1b and <Esc> each represent the escape character. In HyperTerminal, you can create macros by selecting **Key Macros** from the **View** menu. You can assign a macro to almost any key for almost any key combination. Create a macro to represent each function key.

[Table B-1](#) lists the escape sequences that represent a special key or function.



-  **NOTE:** When creating macros in HyperTerminal, press <Insert> before <Esc> to signify that you are sending an escape sequence rather than escaping out of the dialog box. If you do not have this function, you must upgrade HyperTerminal.
-  **NOTE:** Escape-sequence key combinations listed in [Table B-1](#) are case-sensitive. For example, to generate the character <A> you must press <Shift><a>.

Table B-1. Supported Escape Sequences

Key(s)	Supported Sequence	Terminal Emulation
<Up arrow>	<Esc><[><A>	VT 100/220, ANSI
<Down arrow>	<Esc><[>	VT 100/220, ANSI
<Right arrow>	<Esc><[><C>	VT 100/220, ANSI
<Left arrow>	<Esc><[><D>	VT 100/220, ANSI
<F1>	<Esc><O><P>	VT 100/220, ANSI
<F2>	<Esc><O><Q>	VT 100/220, ANSI
<F3>	<Esc><O><R>	VT 100/220, ANSI
<F4>	<Esc><O><S>	VT 100/220, ANSI
<F5>	<Esc><O><T>	VT 100, ANSI
<F6>	<Esc><O><U>	VT 100, ANSI
	<Esc><[><1><7><->	VT 100/220
<F7>	<Esc><O><V>	VT 100, ANSI
	<Esc><[><1><8><->	VT 100/220
<F8>	<Esc><O><W>	VT 100, ANSI
	<Esc><[><1><9><->	VT 100/220
<F9>	<Esc><O><X>	VT 100, ANSI
	<Esc><[><2><0><->	VT 100/220
<F10>	<Esc><O><Y>	VT 100, ANSI
	<Esc><[><2><1><->	VT 100/220
<F11>	<Esc><O><Z>	VT 100, ANSI
	<Esc><[><2><3><->	VT 100/220
<F12>	<Esc><O><A>	VT 100, ANSI
	<Esc><[><2><4><->	VT 100/220
<Home>	<Esc><[><1><-> <Esc><h>	VT 220 ANSI
<End>	<Esc><[><4><->	VT 220
	<Esc><k>	ANSI
<Delete>	<Esc><[><3><->	VT 220
	<Esc><->	ANSI
<Delete>	<Esc><[><3><->	VT 220
	<Esc><->	ANSI
<Page Up>	<Esc><[><5><->	VT 220
	<Esc><Shift><?>	ANSI
<Page Down>	<Esc><[><6><->	VT 220
	<Esc></>	ANSI
<Shift><Tab>	<Esc><[><Z>	VT 100
	<Esc><[><0><Z>	VT 220
	<Esc><[><Shift><z>	ANSI

After creating macros for the keys listed in [Table B-1](#), press <F1> on the client system's keyboard during terminal emulation to send the escape sequence <Esc><O><P> to the host system. The host system then interprets the sequence as <F1>.

Additional escape sequences may be required by certain utilities or functions on the host system. Create macros for the additional sequences listed in [Table B-2](#).

-  **NOTE:** Escape-sequence key combinations listed in [Table B-2](#) are case-sensitive. For example, to generate the character <A> you must press <Shift><a>.

Table B-2. Additional Escape Sequences

--	--	--

Key(s)	Supported Sequence
<Ctrl><Alt> (Reboot host system)	<Esc><R><Esc><r><Esc><R>
<Alt><X>	<Esc><X><X>
<Ctrl><H>	<Esc><Ctrl><H>
<Ctrl><I>	<Esc><Ctrl><I>
<Ctrl><J>	<Esc><Ctrl><J>
<Ctrl><M>	<Esc><Ctrl><M>
<Ctrl><2>	<Esc><Ctrl><2>

[Back to Contents Page](#)

System Overview

Dell™ PowerEdge™ 6850 Systems User's Guide

- [Indicators on the Bezel](#)
- [Front-Panel Features and Indicators](#)
- [Back-Panel Features and Indicators](#)
- [Power Indicator Codes](#)
- [System Features](#)
- [Supported Operating Systems](#)
- [Power Protection Devices](#)
- [Other Documents You May Need](#)
- [Obtaining Technical Assistance](#)

This section describes the major hardware and software features of your system and provides information about the indicators on the system's front and back panels. It also provides information about other documents you may need when setting up your system and how to obtain technical assistance.

Indicators on the Bezel

The optional locking system bezel incorporates a system status indicator. The system status indicator lights blue when the system is operating correctly and lights amber when the system needs attention due to a problem with power supplies, fans, system temperature, or hard drives.

[Table 1-1](#) lists the system's indicator patterns. Different patterns are displayed as events occur in the system.

Table 1-1. System Status Indicator Patterns

Blue indicator	Amber indicator	Description
Off	Off	Power is not available to the system.
Off	Blinking	The system has detected an error. See your <i>Installation and Troubleshooting Guide</i> for more information.
On	Off	Power is on, and the system is operational.
Blinking	Off	The indicator has been activated to identify the system in a rack.

NOTE: The blue indicator always blinks during system identification, even if an error has been detected. After the system is identified, the blue indicator stops blinking and the amber indicator resumes blinking.

Front-Panel Features and Indicators

[Figure 1-1](#) shows the controls, indicators, and connectors located behind the optional rack bezel on the system's front panel.

Figure 1-1. Front-Panel Features and Indicators

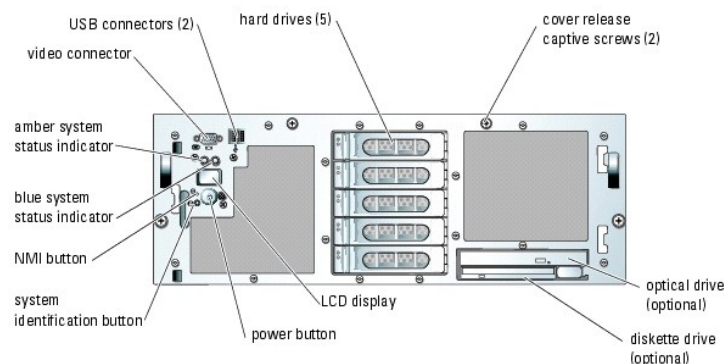







Table 1-2. Front-Panel LED Indicators, Buttons, and Connectors

Indicator, Button, or Connector	Icon	Description
---------------------------------	------	-------------

Blue system status indicator		Does not operate when the bezel is removed. The LCD display indicates the status.
Amber system status indicator		Does not operate when the bezel is removed. The LCD display indicates the status.
LCD display		Provides system ID, status information, and system error messages. The LCD display lights during normal system operation. Both the systems management software and the identification buttons located on the front and back of the system can cause the LCD to flash blue to identify a particular system. The LCD display lights amber when the system needs attention due to a problem with power supplies, fans, system temperature, or hard drives. NOTE: If the system is connected to AC power and an error has been detected, the LCD display flashes amber regardless of whether the system has been powered on.
Power-on indicator, power button		The power-on indicator lights when the system power is on. The power-on indicator blinks when power is available to the system, but the system is not powered on. The power button controls the DC power supply output to the system. NOTE: If you turn off the system using the power button and the system is running an ACPI-compliant operating system, the system performs a graceful shutdown before the power is turned off. If the system is not running an ACPI-compliant operating system, the power is turned off immediately after the power button is pressed.
System identification button		The identification buttons on the front and back panels can be used to locate a particular system within a rack. When one of these buttons is pushed, the blue system status indicator on the front and back blinks until one of the buttons is pushed again.
USB connectors		Connects USB 2.0-compliant devices to the system.
NMI button		Used to troubleshoot software and device driver errors when using certain operating systems. This button can be pressed using the end of a paper clip. Use this button only if directed to do so by qualified support personnel or by the operating system's documentation.
Video connector		Connects a monitor to the system.

SCSI Hard-Drive Indicator Codes

If RAID is activated, two indicators on each of the hard-drive carriers provide information on the status of the SCSI hard drives. RAID can be enabled either by using ROMB or by using a RAID card connected to the backplane. See [Figure 1-2](#) and [Table 1-3](#). The SCSI backplane firmware controls the drive power-on/fault indicator.

Figure 1-2. SCSI Hard-Drive Indicators

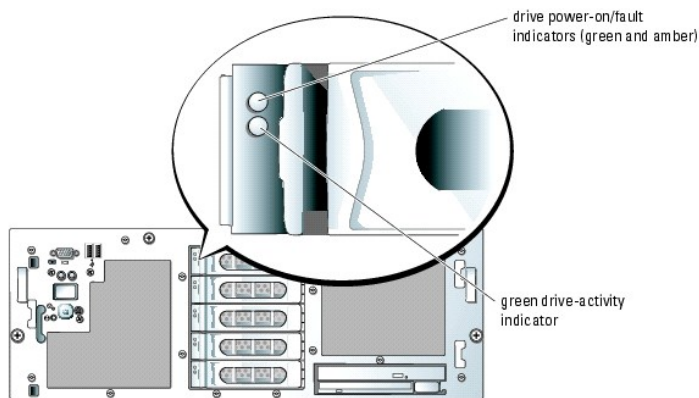

[Table 1-3](#) lists the drive indicator patterns. Different patterns are displayed as drive events occur in the system. For example, if a hard drive fails, the "drive failed" pattern appears. After the drive is selected for removal, the "drive being prepared for removal" pattern appears, followed by the "drive ready for insertion or removal" pattern. After the replacement drive is installed, the "drive being prepared for operation" pattern appears, followed by the "drive online" pattern.

 **NOTE:** If a RAID controller is not present, the green power-on/fault indicator is on if power is available to the drive. The drive-activity indicator also blinks when the drive is being accessed.

Table 1-3. Hard-Drive Indicator Patterns

Condition	Indicator Pattern
Identify drive	The green power-on/fault indicator blinks four times per second.
Drive being prepared for removal	The green power-on/fault indicator blinks two times per second.
Drive ready for insertion or removal	Both drive indicators are off.
Drive being prepared for operation	The green power-on/fault indicator is on.
Drive predicted failure	The power-on/fault indicator slowly blinks green, amber, and off.
Drive failed	The amber power-on/fault indicator blinks four times per second.
Drive rebuilding	The green power-on/fault indicator blinks slowly.
Drive online	The green power-on/fault indicator is on.

Back-Panel Features and Indicators

[Figure 1-3](#) shows the controls, indicators, and connectors located on the system's back panel.

Figure 1-3. Back-Panel Features and Indicators

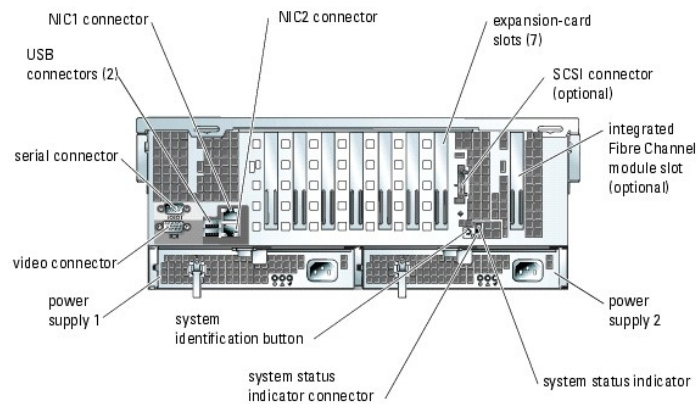

Connecting External Devices

When connecting external devices to your system, follow these guidelines:

- 1 Most devices must be connected to a specific connector and device drivers must be installed before the device operates properly. (Device drivers are normally included with your operating system software or with the device itself.) See the documentation that accompanied the device for specific installation and configuration instructions.
- 1 Always attach external devices while your system is turned off. Next, turn on any external devices before turning on the system (unless the documentation for the device specifies otherwise).

For information about individual connectors, see your *Installation and Troubleshooting Guide*. For information about enabling, disabling, and configuring I/O ports and connectors, see "[Using the System Setup Program](#)."

Power Indicator Codes

The power button on the front panel controls the power input to the system's power supplies. The power indicator can provide information on power status (see [Figure 1-1](#)). [Table 1-4](#) lists the power button indicator codes.

Table 1-4. Power Button Indicators

Indicator	Function
On	Indicates that power is supplied to the system and the system is operational.
Off	Indicates that no power is supplied to the system.
Blinking	Indicates that power is supplied to the system, but the system is in a standby state. For information on standby states, see your operating system documentation.

The indicators on the redundant power supplies show whether power is present or whether a power fault has occurred (see [Table 1-5](#) and [Figure 1-4](#)).

NOTE: The 1470-W power supplies require 200–240 V to operate. If they are plugged into 110-V electrical outlets, the power supplies do not power up.

Table 1-5. Redundant Power Supply Indicators

Indicator	Function
Power supply status	Green indicates that the power supply is operational.
Power supply fault	Amber indicates a problem with the power supply.
AC line status	Green indicates that a valid AC source is connected to the power supply.

Figure 1-4. Redundant Power Supply Indicators

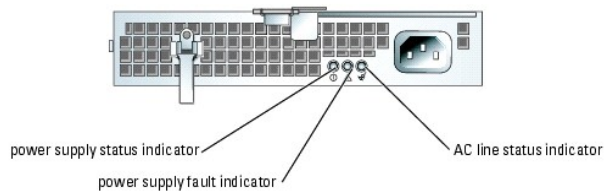

System Features

- 1 Up to four Intel® Xeon™ processors with an internal operating speed of at least 3.16 GHz, internal cache of at least 1 MB, and a front-side bus operating at 667 MHz.
- 1 Support for symmetric multiprocessing (SMP), which is available on systems with up to three additional Intel Xeon processors. SMP greatly improves overall system performance by dividing processor operations between independent processors. To take advantage of this feature, you must use an operating system that supports multiprocessing.

NOTE: If you decide to upgrade your system by installing additional processors, you must order the processor upgrade kits from Dell. Not all versions of the Intel Xeon processor will work properly as additional processors. The upgrade kit from Dell contains the correct version of the processor and heat sink, as well as the instructions for performing the upgrade. All processors must have the same internal operating frequency and cache size.

- 1 A minimum of 512 MB of registered PC2-3200 DDR 2 400 SDRAM memory modules, upgradable to a maximum of 64 GB by installing combinations of 256-MB, 512-MB, 1-GB, 2-GB, or 4-GB (when available) 2-way interleaving memory modules in up to four hot-pluggable memory risers on the system board.

NOTE: The chip fail feature is only supported using x4 and x8 memory modules.

The system also features redundant memory, which provides memory mirroring, a failover memory bank, or memory RAID. These features are selectable through the System Setup program when memory configuration requirements are met (see ["Using the System Setup Program"](#)).

- 1 Support for up to five 1-inch, internal hot-pluggable U320 SCSI hard drives. An optional daughter card provides support for a 2+3 split backplane.
- 1 An optional Integrated Fibre Channel Module, incorporating two 2-GB connectors.
- 1 An optional single, 1.44-MB, 3.5-inch diskette drive.
- 1 An optional IDE CD, DVD, or combination CD-RW/DVD drive.

NOTE: DVD devices are data only.

- 1 An intrusion switch that signals the appropriate systems management software if the top cover is opened.
- 1 Two hot-pluggable, 1470-W power supplies in a 1 + 1 redundant configuration.
- 1 Four redundant, hot-pluggable system cooling fans.

The system board includes the following features:

- 1 Seven PCI slots. PCI slot 1 is a hot-pluggable PCIe x8 lane slot; slot 2 is a hot-pluggable 64-bit, 133-MHz PCI-X slot; slots 3 through 5 are hot-pluggable PCIe x4 lane slots; and slots 6 and 7 are 64-bit, 100-MHz PCI-X slots. Expansion-card slots 1 through 6 accommodate full-height, full-length expansion cards. Slot 7 is a full-height, half-length slot.
- 1 An integrated, dual-channel U320 SCSI host adapter. The internal channel supports up to five SCSI hard drives using the 1x5 or, with the optional daughter card installed, the 2+3 SCSI backplane. The SCSI backplane automatically configures SCSI ID numbers and SCSI termination, greatly simplifying drive installation.
- 1 Optional ROMB activated by using a ROMB key, a 256-MB DDR2 400 memory module, and a RAID battery.
- 1 Optional RAID through a separate controller card that incorporates 128 MB of cache memory and a RAID battery.

- 1 Two integrated Gigabit Ethernet NICs, capable of supporting 10-Mbps, 100-Mbps, and 1000-Mbps data rates.
- 1 Four USB 2.0-compliant connectors (two on the front and two on the back) capable of supporting a diskette drive, a CD-ROM drive, a keyboard, a mouse, or a USB flash drive.
- 1 Optional remote access controller (RAC) for remote systems management. The optional RAC must be installed in PCI slot 7.
- 1 An integrated VGA-compatible video subsystem with an ATI Radeon 7000, 33-MHz PCI video controller. This video subsystem contains 16 MB of SDRAM video memory (nonupgradable). Maximum resolution is 1600 x 1200 with 64,000 colors; true-color graphics are supported in the following resolutions: 640 x 480, 800 x 600, 1024 x 768, 1152 x 864, and 1280 x 1024. When the optional RAC is installed, the integrated video subsystem is disabled and the video controller on the RAC is used instead.
- 1 Systems management circuitry that monitors operation of the system fans as well as critical system voltages and temperatures. The systems management circuitry works in conjunction with the systems management software.
- 1 Standard baseboard management controller with serial access.
- 1 Back-panel connectors include serial, video, SCSI (optional), two USB connectors, and two NIC connectors.
- 1 Front-panel connectors include a video and two USB connectors.
- 1 Front-panel LCD display for system ID and error messaging.
- 1 System ID button on the front and back panels.

For more information about specific features, see "[Technical Specifications](#)."

The following software is included with your system:

- 1 A System Setup program for quickly viewing and changing system configuration information. For more information on this program, see "[Using the System Setup Program](#)."
- 1 Enhanced security features, including a system password and a setup password, available through the System Setup program.
- 1 System diagnostics for evaluating system components and devices. For information about using the system diagnostics, see "Running the System Diagnostics" in your *Installation and Troubleshooting Guide*.
- 1 Video drivers for displaying many popular application programs in high-resolution modes.
- 1 SCSI device drivers that allow the operating system to communicate with devices attached to the integrated SCSI subsystem. For more information about these drivers, see "Installing Drives" in your *Installation and Troubleshooting Guide*.
- 1 Systems management software and documentation CDs.

Supported Operating Systems

- 1 Microsoft® Windows® 2000 Server and Advanced Server
- 1 Microsoft Windows Server 2003 Standard and Enterprise Editions
- 1 Red Hat® Enterprise Linux AS (version 3) for Intel x86
- 1 Red Hat Enterprise Linux AS (version 3) for Intel Extended Memory 64 Technology (Intel EM64T)

Power Protection Devices

Certain devices protect your system from the effects of problems such as power surges and power failures.

- 1 PDU — Uses circuit breakers to ensure that the AC current load does not exceed the PDU's rating.
- 1 Surge protector — Prevents voltage spikes, such as those that may occur during an electrical storm, from entering the system through the electrical outlet. They do not protect against brownouts, which occur when the voltage drops more than 20 percent below the normal AC line voltage level.
- 1 Line conditioner — Maintains a system's AC power source voltage at a moderately constant level and provides protection from brownouts, but does not protect against a complete power loss.
- 1 UPS — Uses battery power to keep the system running when AC power is unavailable. The battery is charged by AC power while it is available so that after AC power is lost, the battery can provide power to the system for a limited amount of time—from 5 minutes to approximately an hour. A UPS that provides only 5 minutes of battery power allows you to save your files and to shut down the system. Use surge protectors and PDUs with all universal power supplies, and ensure that the UPS is UL-safety approved.

Other Documents You May Need

 The *Product Information Guide* provides important safety and regulatory information. Warranty information may be included within this document or as a separate document.

- 1 The *Rack Installation Guide* or *Rack Installation Instructions* included with your rack solution describes how to install your system into a rack.
- 1 The *Getting Started Guide* provides an overview of initially setting up your system.
- 1 The *Installation and Troubleshooting Guide* describes how to troubleshoot the system and install or replace system components.
- 1 Systems management software documentation describes the features, requirements, installation, and basic operation of the software.

- 1 Baseboard management controller (BMC) documentation describes the features and configuration options of the BMC.
- 1 Operating system documentation describes how to install (if necessary), configure, and use the operating system software.
- 1 Documentation for any components you purchased separately provides information to configure and install these options.
- 1 Updates are sometimes included with the system to describe changes to the system, software, and/or documentation.

 **NOTE:** Always check for updates on support.dell.com and read the updates first because they often supersede information in other documents.

- 1 Release notes or readme files may be included to provide last-minute updates to the system or documentation or advanced technical reference material intended for experienced users or technicians.

Obtaining Technical Assistance

If you do not understand a procedure in this guide or if the system does not perform as expected, see your *Installation and Troubleshooting Guide*.

Dell Enterprise Training and Certification is available; see www.dell.com/training for more information. This service may not be offered in all locations.

[Back to Contents Page](#)

[Back to Contents Page](#)

Using the Dell OpenManage Server Assistant

Dell™ PowerEdge™ 6850 Systems User's Guide

- [Starting the Server Assistant CD](#)
- [Using the Server Setup Program](#)
- [Updating Drivers and Utilities](#)
- [Using the Utility Partition](#)

The *Dell OpenManage Server Assistant* CD contains utilities, diagnostics, and drivers to help you configure your system. You begin the operating system installation with this CD if your operating system was not preinstalled on your system. A bootable utility partition on the system's hard drive contains some of the same functionality as the *Server Assistant* CD.

Starting the Server Assistant CD

To configure your system and install your operating system, insert the *Server Assistant* CD, and turn on or reboot the system. The **Dell OpenManage Server Assistant** main screen appears.

If the CD does not boot, verify that the CD drive is specified first in the **Boot Sequence** option in the System Setup program (see "[Using the System Setup Program](#)").

The *Server Assistant* CD uses a standard Web browser interface. You can navigate the CD by using the mouse to click various icons and text links.

Click the **Exit** icon to exit Server Assistant. If you exit Server Assistant while in the Server Setup program, the system reboots to the standard operating system boot partition.

Using the Server Setup Program

If the operating system is not preinstalled or if you install an operating system at a later date, use the Server Setup program on the *Server Assistant* CD to configure your system and install your operating system.

 **NOTE:** Use the *Server Assistant* CD only if your operating system is not preinstalled on your system. Locate the operating system's *Installation Instructions* document and follow the instructions to complete the installation process.

The Server Setup program guides you through tasks such as the following:

- 1 Setting the system date and time
- 1 Configuring your RAID controller (if applicable)
- 1 Selecting and installing your operating system; specifying operating system-specific information
- 1 Configuring hard drives
- 1 Viewing the installation summary

 **NOTE:** You must have your operating system media available to install your operating system.

To start the Server Setup program, click **Server Setup** on the **Dell OpenManage Server Assistant** main screen. Follow the instructions on the screen.

Updating Drivers and Utilities

You can update drivers and utilities on any system that has Microsoft® Internet Explorer 5.5 or later or Netscape Navigator 7.02 or later installed. When you insert the CD into the CD drive on a system that uses a Microsoft Windows®-based operating system, the system automatically starts the browser and displays the **Dell OpenManage Server Assistant** main screen.

To update drivers and utilities, perform the following steps:

1. From the **Dell OpenManage Server Assistant** main screen, select the option for updating drivers and utilities.
2. Select the system model number from the drop-down box.
3. Select the type of drivers or utilities that you want to update.
4. Click **Continue**.
5. Select each driver or utility that you want to update.

You are prompted to either run the program or provide a location to save the files.

6. Run the program or specify the location to save the files.
-

Using the Utility Partition

The utility partition is a bootable partition on the hard drive that contains system configuration and diagnostic utilities. When you start the utility partition, it boots and provides an executable environment for the partition's utilities.

To start the utility partition, turn on or reboot the system. During POST, press <F10> after the following message appears:

<F10> = Utility Mode

 **NOTE:** The utility partition provides only limited MS-DOS® functionality and cannot be used as a general-purpose MS-DOS partition.

The utility partition provides a text-based interface from which you can run the partition's utilities. To select a menu option, use either the arrow keys to highlight the option and press <Enter> or type the number of the menu option. To exit the utility partition, press <Esc> from the **Utility Partition** main menu.

[Table 2-1](#) provides a sample list and explanation of the options that appear on the utility partition menu. These options are available even when the *Server Assistant* CD is not in the CD drive.

Table 2-1. Utility Partition Main Menu Options

Option	Description
Run system diagnostics	Runs the system hardware diagnostics
Run RAID configuration utility	Runs the RAID configuration utility if ROMB is enabled or RAID controller card is installed
NOTE: The options displayed may vary depending on your system configuration and may not include those listed here.	

[Back to Contents Page](#)

[Back to Contents Page](#)

Using the System Setup Program

Dell™ PowerEdge™ 6850 Systems User's Guide

- [Entering the System Setup Program](#)
- [System Setup Options](#)
- [System and Setup Password Features](#)
- [Disabling a Forgotten Password](#)
- [Asset Tag Utility](#)
- [Baseboard Management Controller Configuration](#)

After you set up your system, run the System Setup program to familiarize yourself with your system configuration and optional settings. Record the information for future reference.

You can use the System Setup program to:

- 1 Change the system configuration stored in NVRAM after you add, change, or remove hardware
- 1 Set or change user-selectable options—for example, the time or date
- 1 Enable or disable integrated devices
- 1 Correct discrepancies between the installed hardware and configuration settings

Entering the System Setup Program

1. Turn on or restart your system.
2. Press <F2> immediately after you see the following message:

<F2> = System Setup

If your operating system begins to load before you press <F2>, allow the system to finish booting, and then restart your system and try again.

 **NOTE:** To ensure an orderly system shutdown, see the documentation that accompanied your operating system.

Responding to Error Messages

You can enter the System Setup program by responding to certain error messages. If an error message appears while the system is booting, make a note of the message. Before entering the System Setup program, see "System Beep Codes" and "System Messages" in your *Installation and Troubleshooting Guide* for an explanation of the message and suggestions for correcting errors.

Using the System Setup Program

[Table 3-1](#) lists the keys that you use to view or change information on the System Setup program screens and to exit the program.

Table 3-1. System Setup Program Navigation Keys

Keys	Action
Up arrow or <Shift><Tab>	Moves to the previous field.
Down arrow or <Tab>	Moves to the next field.
Spacebar, <+>, <->, left and right arrows	Cycles through the settings in a field. In many fields, you can also type the appropriate value.
<Esc>	Exits the System Setup program and restarts the system if any changes were made.
<F1>	Displays the System Setup program's help file.

 **NOTE:** For most of the options, any changes that you make are recorded but do not take effect until you restart the system.

System Setup Options

Main Screen

When you enter the System Setup program, the main System Setup program screen appears (see [Figure 3-1](#)).

Figure 3-1. Main System Setup Program Screen

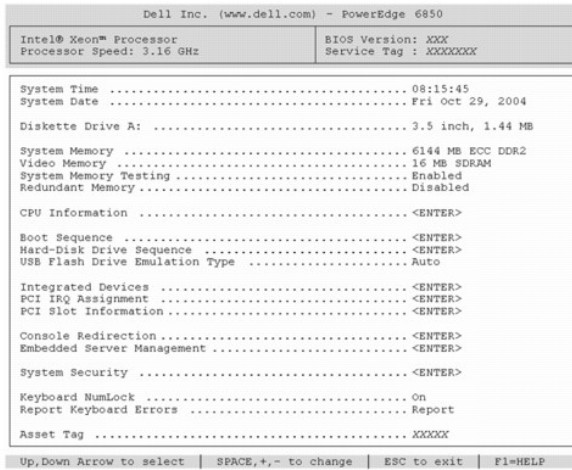

Table 3-2 lists the options and descriptions for the information fields that appear on the main System Setup program screen.



-  **NOTE:** The options for the System Setup program change based on the system configuration.
-  **NOTE:** The System Setup program defaults are listed under their respective options, where applicable.

Table 3-2. System Setup Program Options

Option	Description
System Time	Resets the time on the system's internal clock.
System Date	Resets the date on the system's internal calendar.
Diskette Drive A:	Displays a screen that allows you to select the type of diskette drive for your system.
System Memory	Displays the amount of system memory. This option does not have user-selectable settings.
Video Memory	Displays the amount of video memory. This option does not have user-selectable settings.
System Memory Testing (Enabled default)	Determines if memory is being tested during POST.
Redundant Memory (Disabled default)	Displays Disabled if none of the requirements for the other option settings are met. The following options are available as follows: <ul style="list-style-type: none"> 1 Spare Bank Enabled is selectable if your system has one or more fully populated memory risers, and the memory modules are identical within each riser. 1 Mirror Enabled is selectable if your configuration contains an even number of fully populated memory risers, and the risers of a pair have matching memory configurations. 1 RAID Enabled is selectable if all four risers are fully populated and have matching memory configurations. <p>For more information on memory configurations, see "Memory Module Installation Guidelines" in "Installing System Components" in the <i>Installation and Troubleshooting Guide</i>.</p>
CPU Information	See " CPU Information Screen ."
Boot Sequence	Determines the order in which the system searches for boot devices during system startup. Available options can include the diskette drive, CD drive, hard drives, and network.
Hard-Disk Drive Sequence	Determines the order in which the system searches the hard drives during system startup. The selections depend on the hard drives installed in your system.
USB Flash Drive Emulation Type (Auto default)	Determines the emulation type for a USB flash drive. Hard disk allows the USB flash drive to act as a hard drive. Floppy allows the USB flash drive to act as a removal diskette drive. Auto automatically chooses an emulation type.
Integrated Devices	See " Integrated Devices Screen ."
PCI IRQ Assignment	Displays a screen to change the IRQ assigned to each of the integrated devices on the PCI bus, and any installed expansion cards that require an IRQ.
PCI Slot Information	Displays the following information for each PCI-X and PCIe bus slot: <ul style="list-style-type: none"> 1 For occupied PCI-X slots, the operating frequency, the mode of the slot (PCI or PCI-X), and the device type 1 For occupied PCIe slots, the bandwidth, the link width of the slot (x1, x4, or x8), and the device type 1 For unoccupied slots, the maximum operating frequency or bandwidth and the capable operating mode or link width of the slot
Console Redirection	See " Console Redirection Screen ."
Embedded Server Management	Enables you to customize the front-panel ESM LCD messages or choose the default message setting.
System Security	Displays a screen to configure the system password and setup password features. See " Using the System Password " and " Using the Setup Password " for more information.

Keyboard NumLock (On default)	Determines whether your system starts up with the NumLock mode activated on 101- or 102-key keyboards (does not apply to 84-key keyboards).
Report Keyboard Errors (Report default)	Enables or disables reporting of keyboard errors during the POST. Select Report for host systems that have keyboards attached. Select Do Not Report to suppress all error messages relating to the keyboard or keyboard controller during POST. This setting does not affect the operation of the keyboard itself if a keyboard is attached to the system.
Asset Tag	Displays the customer-programmable asset tag number for the system if an asset tag number has been assigned. To enter an asset tag number of up to 10 characters into NVRAM, see "Asset Tag Utility."

CPU Information Screen

[Table 3-3](#) lists the options and descriptions for the information fields that appear on the **CPU Information** screen.

Table 3-3. CPU Information Screen

Option	Description
Bus Speed	Displays the bus speed of the processors.
Logical Processor (Enabled default)	Displays when the processors support HyperThreading. Enabled permits all logical processors to be used by the operating system. Only the first logical processor of each processor installed in the system is used by the operating system if Disabled is selected.
Sequential Memory Access (Enabled default)	Displays when the processor supports sequential memory access. Enabled optimizes the system for applications that require sequential memory access. Disabled is used for applications with random memory access.
Processor XID	Displays the family and model number of each processor.
Core Speed	Displays the clock speed of the processor(s).
Level X Cache	Displays the amount of cache memory for the processor.

Integrated Devices Screen

[Table 3-4](#) lists the options and descriptions for the information fields that appear on the **Integrated Devices** screen.

Table 3-4. Integrated Devices Screen Options

Option	Description
Primary SCSI Controller (SCSI default)	Enables the integrated SCSI subsystem. This field displays only when RAID is not detected in the system. Off disables the SCSI subsystem. Channel A and Channel B both follow the option selected.
Embedded RAID Controller	Selects between RAID , SCSI , or Off . This field displays only when RAID is detected in the system and the optional ROMB key and memory are installed. Channel A follows the option selected. If Channel A displays RAID , Channel B can be set to either RAID or SCSI . Otherwise, Channel B follows the option selected.
IDE CD-ROM Controller (Auto default)	Enables the integrated IDE controller. When set to Auto , each channel of the integrated IDE controller is enabled if IDE devices are attached to the channel and the external IDE controller is not detected. Otherwise, the channel is disabled.
Diskette Controller (Auto default)	Enables or disables the system's diskette drive controller. When Auto is selected, the system turns off the controller when necessary to accommodate a controller card installed in an expansion slot. You can also configure the drive as read-only. When using the read-only setting, the drive cannot be used to write to a disk.
USB Controller (On with BIOS support default)	Enables or disables the system's USB ports. Options are On with BIOS support , On without BIOS support , or Off . Disabling the USB ports makes system resources available for other devices.
Embedded Gb NIC1 and NIC2 (On default)	Enables or disables the system's integrated NICs. Changes take effect after the system reboots. NOTE: Off will disable both NIC1 and NIC2.
NIC1 PXE (Enabled default)	Enables or disables NIC1 PXE. PXE support allows the system to boot from the network. Changes take effect after the system reboots.
MAC Address	Displays the MAC address for the integrated 10/100/1000 NIC. This field does not have user-selectable settings.
NIC2 PXE (Disabled default)	Enables or disables NIC2 PXE. PXE support allows the system to boot from the network. Changes take effect after the system reboots.
MAC Address	Displays the MAC address for the integrated 10/100/1000 NIC. This field does not have user-selectable settings.
Serial Port 1 (COM1 default)	Serial Port 1 options are COM1 , COM3 , BMC Serial , BMC NIC , and Off . If an optional remote access controller (RAC) is installed in the system, RAC is an additional option. Serial port 1 shares three usage models. For standard usage, serial port 1 attempts to use COM1 first, and then COM3. For BMC usage, serial port 1 uses the COM1 address and communication can be either via the serial port or the integrated shared NIC. RAC control uses only the COM1 address.

	NOTE: Off and COM3 are not available options when Console Redirection is set to use Serial Port 1.
Speaker (On default)	Sets the integrated speaker On or Off . A change to this option takes effect immediately (rebooting the system is not required).

System Security Screen

[Table 3-5](#) lists the options and descriptions for the information fields that appear on the **System Security** screen.

Table 3-5. System Security Screen Options

Option	Description
System Password	Displays the current status of your system's password security feature and allows you to assign and verify a new system password. NOTE: See " Using the System Password " for instructions on assigning a system password and using or changing an existing system password.
Setup Password	Restricts access to the System Setup program in the same way that you restrict access to your system using the system password feature. NOTE: See " Using the Setup Password " for instructions on assigning a setup password and using or changing an existing setup password.
Password Status	Setting the Setup Password option to Enabled prevents the system password from being changed or disabled at system start-up. To lock the system password, assign a setup password in the Setup Password option and then change the Password Status option to Locked . In this state, you cannot change the system password using the System Password option and system password cannot be disabled at system start-up by pressing <Ctrl><Enter>. To unlock the system password, enter the setup password in the Setup Password field and then change the Password Status option to Unlocked . In this state, you can disable the system password at system start-up by pressing <Ctrl><Enter> and then change the password using the System Password option.
Power Button (Enabled default)	Turns system's power off and on. <ul style="list-style-type: none"> 1 If you turn off the system using the power button and the system is running an ACPI-compliant operating system, the system can perform an orderly shutdown before power is turned off. 1 If the system is not running an ACPI-compliant operating system, power is turned off immediately after the power button is pressed. <p>The button is enabled in the System Setup program. When disabled, the button can only turn on system power.</p>
NMI Button (Disabled default)	NOTICE: Use the NMI button only if directed to do so by qualified support personnel or by the operating system's documentation. Pressing this button halts the operating system and displays a diagnostic screen. Sets the NMI feature to Enabled or Disabled .
AC Power Recovery (Last default)	Determines how the system reacts when power is restored to the system. If system is set to Last , the system returns to the last power state. On turns on the system after power is restored. When set to Off , the system remains off after power is restored.

Console Redirection Screen

[Table 3-6](#) lists the options and descriptions for the information fields that appear on the **Console Redirection** screen. For more information about using console redirection, see "[Using Console Redirection](#)."

Table 3-6. Console Redirection Screen Options



Option	Description
Console Redirection (Off default)	Sets the console redirection feature to Serial Port 1 or Off .
Failsafe Baud Rate (11520 default)	Displays if the failsafe baud rate is used for console redirection.
Remote Terminal Type (VT 100/VT 220 default)	Select either VT 100/VT 220 or ANSI .
Redirection After Boot (Enabled default)	Enables or disables console redirection after your system restarts.

Exit Screen

After you press <Esc> to exit the System Setup program, the **Exit** screen displays the following options:

- 1 Save Changes and Exit
 - 1 Discard Changes and Exit
 - 1 Return to Setup
-

System and Setup Password Features

-  **NOTICE:** The password features provide a basic level of security for the data on your system. If your data requires more security, use additional forms of protection, such as data encryption programs.
-  **NOTICE:** Anyone can access the data stored on your system if you leave the system running and unattended without having a system password assigned or if you leave your system unlocked so that someone can disable the password by changing a jumper setting.

Your system is shipped to you without the system password feature enabled. If system security is a concern, operate your system only with system password protection.

To change or delete an existing password, you must know the password (see "[Deleting or Changing an Existing System Password](#)"). If you forget your password, you cannot operate your system or change settings in the System Setup program until a trained service technician changes the password jumper setting to disable the passwords, and erases the existing passwords. This procedure is described in the *Installation and Troubleshooting Guide*.

Using the System Password

After a system password is assigned, only those who know the password have full use of the system. When the **System Password** option is set to **Enabled**, the system prompts you for the system password after the system starts.

Assigning a System Password

Before you assign a system password, enter the System Setup program and check the **System Password** option.

When a system password is assigned, the setting shown for the **System Password** option is **Enabled**. If the setting shown for the **Password Status** is **Unlocked**, you can change the system password. If the **Password Status** option is **Locked**, you cannot change the system password. When the system password feature is disabled by a jumper setting, the system password is **Disabled**, and you cannot change or enter a new system password.

When a system password is not assigned and the password jumper on the system board is in the enabled (default) position, the setting shown for the **System Password** option is **Not Enabled** and the **Password Status** field is **Unlocked**. To assign a system password:

1. Verify that the **Password Status** option is set to **Unlocked**.
2. Highlight the **System Password** option and press <Enter>.
3. Type your new system password.

You can use up to 32 characters in your password.

As you press each character key (or the spacebar for a blank space), a placeholder appears in the field.

The password assignment is not case-sensitive. However, certain key combinations are not valid. If you enter one of these combinations, the system beeps. To erase a character when entering your password, press <Backspace> or the left-arrow key.

 **NOTE:** To escape from the field without assigning a system password, press <Enter> to move to another field, or press <Esc> at any time prior to completing step 5.

4. Press <Enter>.
5. To confirm your password, type it a second time and press <Enter>.

The setting shown for the **System Password** changes to **Enabled**. Exit the System Setup program and begin using your system.

6. Either reboot your system now for your password protection to take effect or continue working.

 **NOTE:** Password protection does not take effect until you reboot the system.

Using Your System Password to Secure Your System

 **NOTE:** If you have assigned a setup password (see "[Using the Setup Password](#)"), the system accepts your setup password as an alternate system password.

When the **Password Status** option is set to **Unlocked**, you have the option to leave the password security enabled or to disable the password security.

To leave the password security enabled:

1. Turn on or reboot your system by pressing <Ctrl><Alt>.
2. Press <Enter>.
3. Type your password and press <Enter>.

To disable the password security:

1. Turn on or reboot your system by pressing <Ctrl><Alt>.
2. Press <Ctrl><Enter>.

When the **Password Status** option is set to **Locked** whenever you turn on your system or reboot your system by pressing <Ctrl><Alt>, type your password and press <Enter> at the prompt.

After you type the correct system password and press <Enter>, your system operates as usual.

If an incorrect system password is entered, the system displays a message and prompts you to re-enter your password. You have three attempts to enter the correct password. After the third unsuccessful attempt, the system displays an error message showing the number of unsuccessful attempts and that the system has halted and will shut down. This message can alert you to an unauthorized person attempting to use your system.

Even after you shut down and restart the system, the error message continues to be displayed until the correct password is entered.

 **NOTE:** You can use the **Password Status** option in conjunction with the **System Password** and **Setup Password** options to further protect your system from unauthorized changes.

Deleting or Changing an Existing System Password

1. When prompted, press <Ctrl><Enter> to disable the existing system password.
If you are asked to enter your setup password, contact your network administrator.
2. Enter the System Setup program by pressing <F2> during POST.
3. Select the **System Security** screen field to verify that the **Password Status** option is set to **Unlocked**.
4. When prompted, type the system password.
5. Confirm that **Not Enabled** is displayed for the **System Password** option.

If **Not Enabled** is displayed for the **System Password** option, the system password has been deleted. If **Enabled** is displayed for the **System Password** option, press the <Alt> key combination to restart the system, and then repeat steps 2 through 5.

Using the Setup Password

Assigning a Setup Password

You can assign (or change) a setup password only when the **Setup Password** option is set to **Not Enabled**. To assign a setup password, highlight the **Setup Password** option and press the <+> or <-> key. The system prompts you to enter and verify the password. If a character is illegal for password use, the system beeps.

 **NOTE:** The setup password can be the same as the system password. If the two passwords are different, the setup password can be used as an alternate system password. However, the system password cannot be used in place of the setup password.

You can use up to 32 characters in your password.

As you press each character key (or the spacebar for a blank space), a placeholder appears in the field.

The password assignment is not case-sensitive. However, certain key combinations are not valid. If you enter one of these combinations, the system beeps. To erase a character when entering your password, press <Backspace> or the left-arrow key.

After you verify the password, the **Setup Password** setting changes to **Enabled**. The next time you enter the System Setup program, the system prompts you for the setup password.

A change to the **Setup Password** option becomes effective immediately (restarting the system is not required).

Operating With a Setup Password Enabled

If **Setup Password** is set to **Enabled**, you must enter the correct setup password before you can modify most of the System Setup options. When you start the System Setup program, the program prompts you to enter a password.

If you do not enter the correct password in three attempts, the system lets you view, but not modify, the System Setup screens—with the following exception: If **System Password** is not set to **Enabled** and is not locked through the **Password Status** option, you can assign a system password (however, you cannot disable or change an existing system password).

 **NOTE:** You can use the **Password Status** option in conjunction with the **Setup Password** option to protect the system password from unauthorized changes.

Deleting or Changing an Existing Setup Password

1. Enter the System Setup program and select the **System Security** option.
2. Highlight the **Setup Password** option, press <Enter> to access the setup password window, and press <Enter> twice to clear the existing setup password.

The setting changes to **Not Enabled**.

3. If you want to assign a new setup password, perform the steps in "[Assigning a Setup Password](#)."

Disabling a Forgotten Password

See your *Installation and Troubleshooting Guide*.

Asset Tag Utility

You can use the Asset Tag utility to assign a unique tracking number to your system. This number is displayed on the System Setup program main screen.

 **NOTE:** The Asset Tag utility works only with operating systems that support MS-DOS®-based applications.

Creating the Asset Tag Utility Diskette

1. Insert the *Dell OpenManage Server Assistant* CD into the CD drive of a system running a Microsoft® Windows® operating system.
2. Insert a blank diskette into the system's diskette drive.
3. Select the system for which you want to create an asset tag and click **Continue**.
4. On the **Utilities and Drivers Page**, select **Dell: Bootable Diskette with Asset Tag Utility**.
5. Save the utility to the hard drive and then execute the utility to create a bootable diskette.
6. Insert the diskette into the system for which you want to assign the asset tag and reboot the system.

Assigning or Deleting an Asset Tag Number

1. Insert the Asset Tag utility diskette that you created into the diskette drive, and reboot the system.
2. You can either assign or delete an asset tag number.

- 1 To assign an asset tag number, type `asset` and a space followed by the new string.

An asset tag number can have up to 10 characters. Any combination of characters (excluding |, <, >) is valid; however, do not use - as the first character. For example, at the `a:\>` prompt, type the following command and press <Enter>:

```
asset 12345abcde
```

- 1 To delete an asset tag number without assigning a new one, type `asset /d` and press <Enter>.

- 1 When prompted to verify the change to the asset tag number, type `y` and press <Enter>.

To view the Asset Tag utility help screen, type `asset /?` and press <Enter>.

Baseboard Management Controller Configuration

The Baseboard Management Controller (BMC) enables configuring, monitoring, and recovery of systems remotely. BMC provides the following features:

- 1 Uses the system's serial port and integrated NIC
- 1 Fault logging and SNMP alerting
- 1 Access to system event log and sensor status
- 1 Control of system functions including power on and off
- 1 Support is independent of the system's power or operating state
- 1 Provides text console redirection for system setup, text-based utilities, and operating system consoles

 **NOTE:** To use the BMC feature, you must connect the network connection to integrated NIC1. See [Figure 1-3](#).

Entering the BMC Setup Module

1. Turn on or restart your system.
2. Press <Ctrl><E> when prompted after POST.

If your operating system begins to load before you press <Ctrl><E>, allow the system to finish booting, and then restart your system and try again.

For additional information on using and configuring BMC, see the documentation for the BMC and systems management applications.

[Back to Contents Page](#)

Glossary

Dell™ PowerEdge™ 6850 Systems User's Guide

This section defines or identifies technical terms, abbreviations, and acronyms used in your system documents.

A — Ampere(s).
AC — Alternating current.
ACPI — Advanced Configuration and Power Interface. A standard interface for enabling the operating system to direct configuration and power management.
ambient temperature — The temperature of the area or room where the system is located.
ANSI — American National Standards Institute. The primary organization for developing technology standards in the U.S.
application — Software designed to help you perform a specific task or series of tasks. Applications run from the operating system.
ASCII — American Standard Code for Information Interchange.
asset tag — An individual code assigned to a system, usually by an administrator, for security or tracking purposes.
backup — A copy of a program or data file. As a precaution, back up your system's hard drive on a regular basis. Before making a change to the configuration of your system, back up important start-up files from your operating system.
backup battery — A battery that maintains system configuration, date, and time information in a special section of memory when the system is turned off.
beep code — A diagnostic message in the form of a pattern of beeps from your system's speaker. For example, one beep, followed by a second beep, and then a burst of three beeps is beep code 1-1-3.
BIOS — Basic input/output system. Your system's BIOS contains programs stored on a flash memory chip. The BIOS controls the following: <ul style="list-style-type: none">1 Communications between the processor and peripheral devices1 Miscellaneous functions, such as system messages
bit — The smallest unit of information interpreted by your system.
blade — A module that contains a processor, memory, and a hard drive. The modules are mounted into a chassis that includes power supplies and fans.
BMC — Baseboard management controller.
boot routine — A program that clears all memory, initializes devices, and loads the operating system when you start your system. Unless the operating system fails to respond, you can reboot (also called <i>warm boot</i>) your system by pressing <Ctrl><Alt>. Otherwise, you must restart the system by pressing the reset button or by turning the system off and then back on.
bootable diskette — A diskette that is used to start your system if the system will not boot from the hard drive.
BTU — British thermal unit.
bus — An information pathway between the components of a system. Your system contains an expansion bus that allows the processor to communicate with controllers for the peripheral devices connected to the system. Your system also contains an address bus and a data bus for communications between the processor and RAM.
C — Celsius.
cache — A fast storage area that keeps a copy of data or instructions for quick data retrieval. When a program makes a request to a disk drive for data that is in the cache, the disk-cache utility can retrieve the data from RAM faster than from the disk drive.
CD — Compact disc. CD drives use optical technology to read data from CDs.
cm — Centimeter(s).
cmos — Complementary metal-oxide semiconductor.
component — As they relate to DMI, components include operating systems, computer systems, expansion cards, and peripherals that are compatible with DMI. Each component is made up of groups and attributes that are defined as relevant to that component.
COMn — The device names for the serial ports on your system.
control panel — The part of the system that contains indicators and controls, such as the power button and power indicator.
controller — A chip that controls the transfer of data between the processor and memory or between the processor and a peripheral.
conventional memory — The first 640 KB of RAM. Conventional memory is found in all systems. Unless they are specially designed, MS-DOS® programs are limited to running in conventional memory.
coprocessor — A chip that relieves the system's processor of specific processing tasks. A math coprocessor, for example, handles numeric processing.
CPU — Central processing unit. See <i>processor</i> .
DC — Direct current.
DDR — Double-data rate. A technology in memory modules that potentially doubles the output.
device driver — A program that allows the operating system or some other program to interface correctly with a peripheral. Some device drivers—such as network drivers—must be loaded from the config.sys file or as memory-resident programs (usually, from the autoexec.bat file). Others must load when you start the program for which they were designed.
DHCP — Dynamic Host Configuration Protocol. A method of automatically assigning an IP address to a client system.
diagnostics — A comprehensive set of tests for your system.
DIMM — Dual in-line memory module. See also <i>memory module</i> .
DIN — <i>Deutsche Industrie Norm</i> .
directory — Directories help keep related files organized on a disk in a hierarchical, "inverted tree" structure. Each disk has a "root" directory. Additional directories that branch off the root directory are called <i>subdirectories</i> . Subdirectories may contain additional directories branching off them.
DMA — Direct memory access. A DMA channel allows certain types of data transfer between RAM and a device to bypass the processor.
DMI — Desktop Management Interface. DMI enables the management of your system's software and hardware by collecting information about the system's components, such as the operating system, memory, peripherals, expansion cards, and asset tag.

DNS — Domain Name System. A method of translating Internet domain names, such as www.dell.com , into IP addresses, such as 143.166.83.200.
DRAM — Dynamic random-access memory. A system's RAM is usually made up entirely of DRAM chips.
DVD — Digital versatile disc.
ECC — Error checking and correction.
EEPROM — Electronically erasable programmable read-only memory.
EMC — Electromagnetic compatibility.
EMI — Electromagnetic interference.
ERA — Embedded remote access. ERA allows you to perform remote, or "out-of-band," server management on your network server using a remote access controller.
ESD — Electrostatic discharge.
ESM — Embedded server management.
expansion bus — Your system contains an expansion bus that allows the processor to communicate with controllers for peripherals, such as NICs.
expansion card — An add-in card, such as a NIC or SCSI adapter, that plugs into an expansion-card connector on the system board. An expansion card adds some specialized function to the system by providing an interface between the expansion bus and a peripheral.
expansion-card connector — A connector on the system board or riser board for plugging in an expansion card.
F — Fahrenheit.
FAT — File allocation table. The file system structure used by MS-DOS to organize and keep track of file storage. The Microsoft® Windows® operating systems can optionally use a FAT file system structure.
flash memory — A type of EEPROM chip that can be reprogrammed from a utility on diskette while still installed in a system; most EEPROM chips can only be rewritten with special programming equipment.
format — To prepare a hard drive or diskette for storing files. An unconditional format deletes all data stored on the disk.
FSB — Front-side bus. The FSB is the data path and physical interface between the processor and the main memory (RAM).
ft — Feet.
FTP — File transfer protocol.
g — Gram(s).
G — Gravities.
Gb — Gigabit(s); 1024 megabits or 1,073,741,824 bits.
GB — Gigabyte(s); 1024 megabytes or 1,073,741,824 bytes. However, when referring to hard-drive capacity, the term is usually rounded to 1,000,000,000 bytes.
graphics mode — A video mode that can be defined as x horizontal by y vertical pixels by z colors.
group — As it relates to DMI, a group is a data structure that defines common information, or attributes, about a manageable component.
guarding — A type of data redundancy in which a set of physical drives stores data and an additional drive stores parity data. See also <i>mirroring</i> , <i>striping</i> , and <i>RAID</i> .
h — Hexadecimal. A base-16 numbering system, often used in programming to identify addresses in the system's RAM and I/O memory addresses for devices. In text, hexadecimal numbers are often followed by <i>h</i> .
headless system — A system or device that functions without having a keyboard, mouse, or monitor attached. Normally, headless systems are managed over a network using an Internet browser.
host adapter — A host adapter implements communication between the system's bus and the controller for a peripheral device. (Hard-drive controller subsystems include integrated host adapter circuitry.) To add a SCSI expansion bus to your system, you must install or connect the appropriate host adapter.
Hz — Hertz.
I/O — Input/output. A keyboard is an input device, and a monitor is an output device. In general, I/O activity can be differentiated from computational activity.
ID — Identification.
IDE — Integrated drive electronics. A standard interface between the system board and storage devices.
integrated mirroring — Provides simultaneous physical mirroring of two drives. Integrated mirroring functionality is provided by the system's hardware. See also <i>mirroring</i> .
internal processor cache — An instruction and data cache built into the processor.
IP — Internet Protocol.
IPX — Internet package exchange.
IRQ — Interrupt request. A signal that data is about to be sent to or received by a peripheral device travels by an IRQ line to the processor. Each peripheral connection must be assigned an IRQ number. Two devices can share the same IRQ assignment, but you cannot operate both devices simultaneously.
jumper — Small blocks on a circuit board with two or more pins emerging from them. Plastic plugs containing a wire fit down over the pins. The wire connects the pins and creates a circuit, providing a simple and reversible method of changing the circuitry in a board.
K — Kilo-; 1000.
Kb — Kilobit(s); 1024 bits.
KB — Kilobyte(s); 1024 bytes.
Kbps — Kilobit(s) per second.
KBps — Kilobyte(s) per second.
key combination — A command requiring you to press multiple keys at the same time (for example, <Ctrl><Alt>).
kg — Kilogram(s); 1000 grams.
kHz — Kilohertz.
KMM — Keyboard/monitor/mouse.
KVM — Keyboard/video/mouse. KVM refers to a switch that allows selection of the system from which the video is displayed and for which the keyboard and mouse are used.

LAN — Local area network. A LAN is usually confined to the same building or a few nearby buildings, with all equipment linked by wiring dedicated specifically to the LAN.
lb — Pound(s).
LCD — Liquid crystal display.
LED — Light-emitting diode. An electronic device that lights up when a current is passed through it.
Linux — A version of the UNIX® operating system that runs on a variety of hardware systems. Linux is open source software, which is freely available; however, the full distribution of Linux along with technical support and training are available for a fee from vendors such as Red Hat Software.
local bus — On a system with local-bus expansion capability, certain peripheral devices (such as the video adapter circuitry) can be designed to run much faster than they would with a traditional expansion bus. See also <i>bus</i> .
LVD — Low voltage differential.
m — Meter(s).
mA — Milliampere(s).
MAC address — Media Access Control address. Your system's unique hardware number on a network.
mAh — Milliampere-hour(s).
Mb — Megabit(s); 1,048,576 bits.
MB — Megabyte(s); 1,048,576 bytes. However, when referring to hard-drive capacity, the term is often rounded to mean 1,000,000 bytes.
Mbps — Megabits per second.
MBps — Megabytes per second.
MBR — Master boot record.
memory address — A specific location, usually expressed as a hexadecimal number, in the system's RAM.
memory module — A small circuit board containing DRAM chips that connects to the system board.
memory — An area in your system that stores basic system data. A system can contain several different forms of memory, such as integrated memory (ROM and RAM) and add-in memory modules (DIMMs).
MHz — Megahertz.
mirroring — A type of data redundancy in which a set of physical drives stores data and one or more sets of additional drives stores duplicate copies of the data. Mirroring functionality is provided by software. See also <i>guarding</i> , <i>integrated mirroring</i> , <i>striping</i> , and <i>RAID</i> .
mm — Millimeter(s).
ms — Millisecond(s).
MS-DOS® — Microsoft Disk Operating System.
NAS — Network Attached Storage. NAS is one of the concepts used for implementing shared storage on a network. NAS systems have their own operating systems, integrated hardware, and software that are optimized to serve specific storage needs.
NIC — Network interface controller. A device that is installed or integrated in a system to allow connection to a network.
NMI — Nonmaskable interrupt. A device sends an NMI to signal the processor about hardware errors.
ns — Nanosecond(s).
NTFS — The NT File System option in the Windows 2000 operating system.
NVRAM — Nonvolatile random-access memory. Memory that does not lose its contents when you turn off your system. NVRAM is used for maintaining the date, time, and system configuration information.
parity — Redundant information that is associated with a block of data.
partition — You can divide a hard drive into multiple physical sections called <i>partitions</i> with the fdisk command. Each partition can contain multiple logical drives. You must format each logical drive with the format command.
PCI — Peripheral Component Interconnect. A standard for local-bus implementation.
PDU — Power distribution unit. A power source with multiple power outlets that provides electrical power to servers and storage systems in a rack.
peripheral — An internal or external device, such as a diskette drive or keyboard, connected to a system.
PGA — Pin grid array. A type of processor socket that allows you to remove the processor chip.
pixel — A single point on a video display. Pixels are arranged in rows and columns to create an image. A video resolution, such as 640 x 480, is expressed as the number of pixels across by the number of pixels up and down.
POST — Power-on self-test. Before the operating system loads when you turn on your system, the POST tests various system components such as RAM and hard drives.
processor — The primary computational chip inside the system that controls the interpretation and execution of arithmetic and logic functions. Software written for one processor must usually be revised to run on another processor. <i>CPU</i> is a synonym for processor.
protected mode — An operating mode that allows operating systems to implement: <ul style="list-style-type: none"> 1 A memory address space of 16 MB to 4 GB 1 Multitasking 1 Virtual memory, a method for increasing addressable memory by using the hard drive
The Windows 2000 and UNIX 32-bit operating systems run in protected mode. MS-DOS cannot run in protected mode.
PS/2 — Personal System/2.
PXE — Preboot eXecution Environment. A way of booting a system via a LAN (without a hard drive or bootable diskette).
RAC — Remote access controller.
RAID — Redundant array of independent disks. A method of providing data redundancy. Some common implementations of RAID include RAID 0, RAID 1, RAID 5, RAID 10, and RAID 50. See also <i>guarding</i> , <i>mirroring</i> , and <i>striping</i> .
RAM — Random-access memory. The system's primary temporary storage area for program instructions and data. Any information stored in RAM is lost when you turn off your system.
RAS — Remote Access Service. This service allows users running the Windows operating system to remotely access a network from their system using a modem.
readme file — A text file, usually shipped with software or hardware, that contains information supplementing or updating the product's documentation.

read-only file — A read-only file is one that you are prohibited from editing or deleting.
ROM — Read-only memory. Your system contains some programs essential to its operation in ROM code. A ROM chip retains its contents even after you turn off your system. Examples of code in ROM include the program that initiates your system's boot routine and the POST.
ROMB — RAID on motherboard.
rpm — Revolutions per minute.
RTC — Real-time clock.
SATA — Serial Advanced Technology Attachment. A standard interface between the system board and storage devices.
SCSI — Small computer system interface. A n I/O bus interface with faster data transmission rates than standard ports.
SDRAM — Synchronous dynamic random-access memory.
sec — Second(s).
serial port — An I/O port used most often to connect a modem to your system. You can usually identify a serial port on your system by its 9-pin connector.
service tag — A bar code label on the system used to identify it when you call Dell for technical support.
SMART — Self-Monitoring Analysis and Reporting Technology. Allows hard drives to report errors and failures to the system BIOS and then display an error message on the screen.
SMP — Symmetric multiprocessing. Used to describe a system that has two or more processors connected via a high-bandwidth link and managed by an operating system, where each processor has equal access to I/O devices.
SNMP — Simple Network Management Protocol. A standard interface that allows a network manager to remotely monitor and manage workstations.
striping — Disk striping writes data across three or more disks in an array, but only uses a portion of the space on each disk. The amount of space used by a "stripe" is the same on each disk used. A virtual disk may use several stripes on the same set of disks in an array. See also <i>guarding</i> , <i>mirroring</i> , and <i>RAID</i> .
SVGA — Super video graphics array. VGA and SVGA are video standards for video adapters with greater resolution and color display capabilities than previous standards.
system board — As the main circuit board, the system board usually contains most of your system's integral components, such as the processor, RAM, controllers for peripherals, and various ROM chips.
system configuration information — Data stored in memory that tells a system what hardware is installed and how the system should be configured for operation.
system diskette — See <i>bootable diskette</i> .
system memory — See <i>RAM</i> .
System Setup program — A BIOS-based program that allows you to configure your system's hardware and customize the system's operation by setting features such as password protection. Because the System Setup program is stored in NVRAM, any settings remain in effect until you change them again.
system.ini file — A start-up file for the Windows operating system. When you start Windows, it consults the system.ini file to determine a variety of options for the Windows operating environment. Among other things, the system.ini file records which video, mouse, and keyboard drivers are installed for Windows.
TCP/IP — Transmission Control Protocol/Internet Protocol.
termination — Some devices (such as the last device at each end of a SCSI cable) must be terminated to prevent reflections and spurious signals in the cable. When such devices are connected in a series, you may need to enable or disable the termination on these devices by changing jumper or switch settings on the devices or by changing settings in the configuration software for the devices.
UNIX — Universal Internet Exchange. UNIX, the precursor to Linux, is an operating system written in the C programming language.
uplink port — A port on a network hub or switch used to connect to other hubs or switches without requiring a crossover cable.
UPS — Uninterruptible power supply. A battery-powered unit that automatically supplies power to your system in the event of an electrical failure.
USB — Universal Serial Bus. A USB connector provides a single connection point for multiple USB-compliant devices, such as mice and keyboards. USB devices can be connected and disconnected while the system is running.
utility — A program used to manage system resources—memory, disk drives, or printers, for example.
UTP — Unshielded twisted pair. A type of wiring used to connect systems in a business or home to a telephone line.
V — Volt(s).
VAC — Volt(s) alternating current.
VDC — Volt(s) direct current.
VGA — Video graphics array. VGA and SVGA are video standards for video adapters with greater resolution and color display capabilities than previous standards.
video adapter — The logical circuitry that provides (in combination with the monitor) your system's video capabilities. A video adapter may be integrated into the system board or may be an expansion card that plugs into an expansion slot.
video driver — A program that allows graphics-mode application programs and operating systems to display at a chosen resolution with the desired number of colors. Video drivers may need to match the video adapter installed in the system.
video memory — Most VGA and SVGA video adapters include memory chips in addition to your system's RAM. The amount of video memory installed primarily influences the number of colors that a program can display (with the appropriate video drivers and monitor capabilities).
video resolution — Video resolution (800 x 600, for example) is expressed as the number of pixels across by the number of pixels up and down. To display a program at a specific graphics resolution, you must install the appropriate video drivers and your monitor must support the resolution.
W — Watt(s).
WH — Watt-hour(s).
win.ini file — A start-up file for the Windows operating system. When you start Windows, it consults the win.ini file to determine a variety of options for the Windows operating environment. The win.ini file also usually includes sections that contain optional settings for Windows application programs that are installed on the hard drive.
Windows 2000 — An integrated and complete Microsoft Windows operating system that does not require MS-DOS and that provides advanced operating system performance, improved ease of use, enhanced workgroup functionality, and simplified file management and browsing.
Windows Powered — A Windows operating system designed for use on NAS systems. For NAS systems, the Windows Powered operating system is dedicated to file service for network clients.
Windows Server 2003 — A set of Microsoft software technologies that enable software integration through the use of XML Web services. XML Web services are small reusable applications written in XML that allow data to be communicated between otherwise unconnected sources.
XML — Extensible Markup Language. XML is a way to create common information formats and to share both the format and the data on the World Wide Web, intranets, and elsewhere.

ZIF — Zero insertion force.

[Back to Contents Page](#)